

Strategic Academic
Faculty Advisor
Noah Finkelstein
718605 - PE

Deputy CIO
and Director of
Academic Technology
Marin Stanek
637411 - PE

Associate Director for
Academic Technology
Applications
Aisha Jackson
697825 – PE

Associate Director for
Academic Technology
Strategy and Support
Mark Werner
1657 – PE

Sr. Support Analyst
Bryan Melville
703221 – PE

QA & Support Analyst
Lisa Lucas
100826 – ITS

Support Analyst
Joseph Sarmiento
703053 - PE

Captioning & Accessibility
Coordinator
Laura Hamrick
2886 – PE
(2 yr. until 6/5/18)

Support Analyst
James Ashby
1670 - PE

Learning eXperience
Design (LXD) Manager
Mark Gammon
152337 - PE

Shane Schwikert

Generative Design
Manager
Sandra Sawaya
2246 – PE

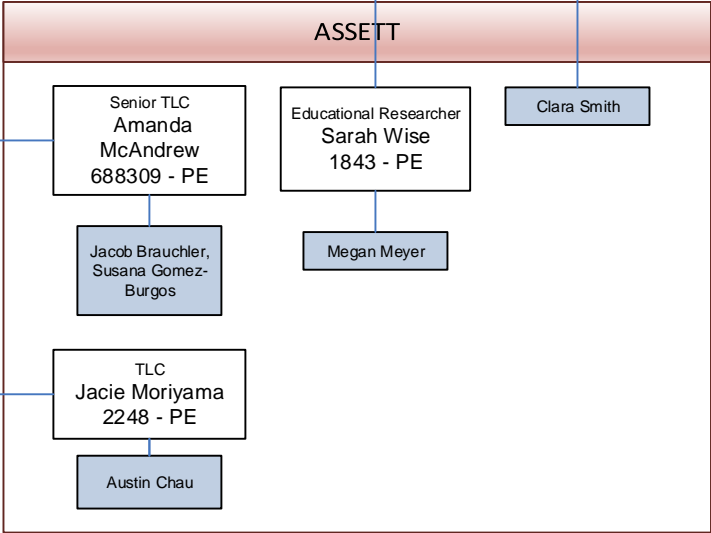

LXD
VACANT
152339 – PE
(formerly Olijnyk)

LXD
Doris Cheung
152345 – PE
(50% FTE)

LXD
Courtney Fell
152343 - PE

LXD
Brad Grabham
677379 – PE

Sara Corry, Zach
Foster, Megan
Meyer, Stephen
Williams

Universal Instructional
Designer
Alaina Beaver
2744 - PE

Peter Cullum,
Joseph Michalsky,
Connor Parrish,
Annika Muehlbradt

**Deputy CIO
And Director of
Academic Technology**
Marin Stanek
637411 - PE

**Associate Director for
Learning Spaces
Technology**
Julian Kinsman
704648 - PE

Learning Spaces
Project Coordinator
Sarah Loftin
700710 – Tech III

**Learning Spaces
Design Manager**
Eric Roster
702260 – PE

**Learning Spaces
Integration Manager**
Guido Ceysens
702131 – PE

**Distance Learning
Services Manager**
Duncan McBogg
708631 – PE

**Video Production
Services Manager**
Colin Mahoney
2440 – PE

**A/V Project
Manager**
Jeremy Carter
2438 - PE

Service Mgr. for
CUClickers
Rob Leary
107483 – ITP

AV Programmer
William Schreiner
708649 – PE

AV Engineer
Dave Monarchi
705930 - PE

AV Engineer
Eric Sherrill
101624 – ITP

Sr. A/V Designer
NEW
TBD – PE
(3yr.)

Sr. A/V Programmer
NEW
TBD – PE
(3 yr.)

AV Specialist
Camalita Ware
2322 – PE

Learning Spaces
Support Coordinator
Louis Fails
102264 -ITP

Deanna Cha, Daniel
Frost, David Griffith,
Bryan Havant, Justin
Hoover, Holden
Huntzinger, Sean
Kowalik, Joaquin
Lagarrigue, Maki
Carter, Nolawee
Mengist, Connor
Monticello, Bryan
O'Hagan, Alex Oliver,
Sean Patterson, Alec
Scheele, Omkar
Seelam, Sam Speir,
Yazen Sus, Logan
Dingwal

**AV Specialist
Manager**
Justin Roberts
708648 – PE

Sr. AV Specialist
Hideo Kawanabe
TBD – PE

Sr. AV Specialist
Timothy Myers
TBD – PE

AV Specialist
Alex Archuleta
725227 – PE
(3 yr. until 7/11/19)

AV Specialist
Jorel Akers
725228 – PE
(3 yrs. until 8/1/19)

Sr. LST Apps Admin
Nicholas
Steinkamp
2423 – PE

Nicholas Han,
Anthony Hauder,
Joseph Heinicke

LST Apps Admin
Dave Buntin
2422 – PE

Delivery Technician
Andrew Bartlett
107860 – IT Tech

Studio Manager
John Azbell
2718 - PE

Asst. Studio Manager
David Helmuth
2497 – PE

Harsh Ashar, Austin
Baysinger, Manal Chhaya,
Dylan Disney, Dewang
Gedia, Olivia Ives, Sriram
Krishnaswamy, Karthik
Kumar, Harrison Mast,
Casey McAndrew, Prema
Nayyar, Alex Ortega, Priya
Parab, Priyanka Pashte,
Jaden Pieper, Alex Reed,
Abhirami Shankar,
Adarshya Sharadha,
Akshay Singh, Vishal
Srivastav, Aayushi
Vatsyayan, Justin Williams

Studio Operator
Chad Farrier
723535 – PE

Studio Operator
Alexandra Reed
TBD – PE

Digital Media Tech
Tim Riggs
107962 – ITP

Michelle Ambruz
Temp Aide

Jim Jewell
Temp Aide

Olivia Ives, Casey
McAndrew,
Alexandria Ortega

Director of Organizational Effectiveness and Customer Engagement
 Jennie Brucker
 698587 – PE

RC Outreach & Business Development Coordinator
 Becky Yeager
 704193 – PE

Associate Director for Business Relationship Management
 Chris Bell
 704820 – PE

Associate Director for Customer Engagement
 Rochelle Scott
 703949 - PE

HR

IT HR Generalist
 Kailei Benedict
 1013 – PE

IT HR Coordinator
 NEW
 tbd – PE

Administrative

Executive Assistant/Office Manager
 Emilia Noullet
 694700 - PE

Exec Assistant/Office Manager
 Oriana Castellucci
 707031 – PE

Printing & Scanning Coordinator
 Mart Eldrenkamp
 107673 – ITT

GDS Manager
 Shane Kroening
 707263 - PE

Business Relationship Coordinator
 Gena Welk
 706470 – PE
 (1 yr. ends 12/31/16
 (85% FTE)

ITSC Manager
 LeCarla Gilmore
 702193 – PE

Communications Professional
 Jamey Chapin
 704654 – PE

PR & Communications Professional
 Greg Stauffer
 1601 - PE

Information Design Manager
 Robert Schwander
 3118 - PE

Peyton Harvey,
 Kaylee Jones,
 Robert Koening,
 Yang Li, Joanne Liu,
 Ethan Cobb

Jack Bartlett, Rajath Bhat, Brett Bloethner, David Bostany, Evan Brookens, Connor Davis, Jennifer Dooley, Bryan Geltz, Dylan Gottlieb, Juan Herrera, Grant Hibner, Adam Jauregui, Dan Le, Dale Pepper, Nathan Phillips, Carl Vitale, Jonathan Wehrend, Mitchell Zinser

Adam Page
 Temp Aide

ITSC Student Supervisor
 Danny Cantu
 708872 - PE

Jacob Bloom, Andy Choung, Hudson Hohimer, Brian Kidd, Alejandro Lopez-Hofer, Jessica Masson, Owen McLaughlin, Lee Pappas, Christian Soto, Phoenix Taylor-Carter, Aaron Vogler, Chase Waller

ITSC Help Desk Analyst
 Nathan Long
 706470 – PE

ITSC Help Desk Analyst
 Guillermo Rodriguez
 706473 - PE

Technical Communications Coordinator
 Kristin Lueck
 703643 – PE

Web Developer
 Miles France
 698062 - PE
 (50% FTE)

**Director of
Finance, Planning & Asset
Management**
Jennifer Nebergall
2305 - PE

Senior Budget Analyst
Irene Hillson
105206 – GP IV

Senior Accounting Analyst
Angela Peters
101002 – Acct II

Accounting Analyst
Erin Stoll
682363 – PE

Accounting Specialist
Sharee Ewudzi-Acquah
637827 – Acct II

Procurement Program Manager
Brian Hutchison
682375 – GP III

Device Lifecycle Program
Manager
Dan Herrick
705317 - PE

**Software Strategy &
Licensing Program
Manager**
Justin Suzuki
66797 - PE

Jamie Nebergall
Temp Aide

Jenny Brown, Joseph
Danni, Marissa
Robles, Rylle Schauer

Sr. Licensing Specialist
Bruce Fast
106950 - PE

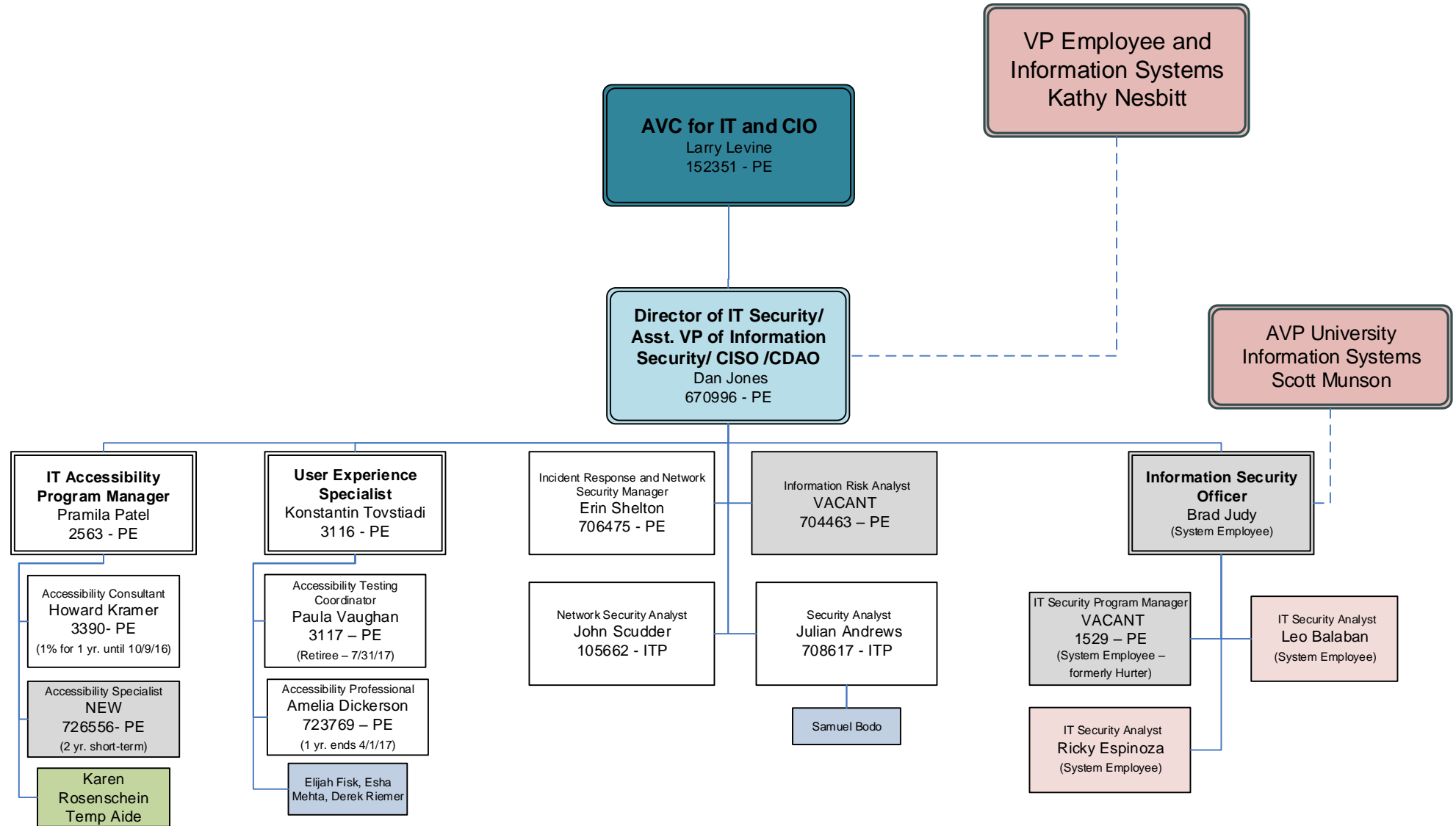

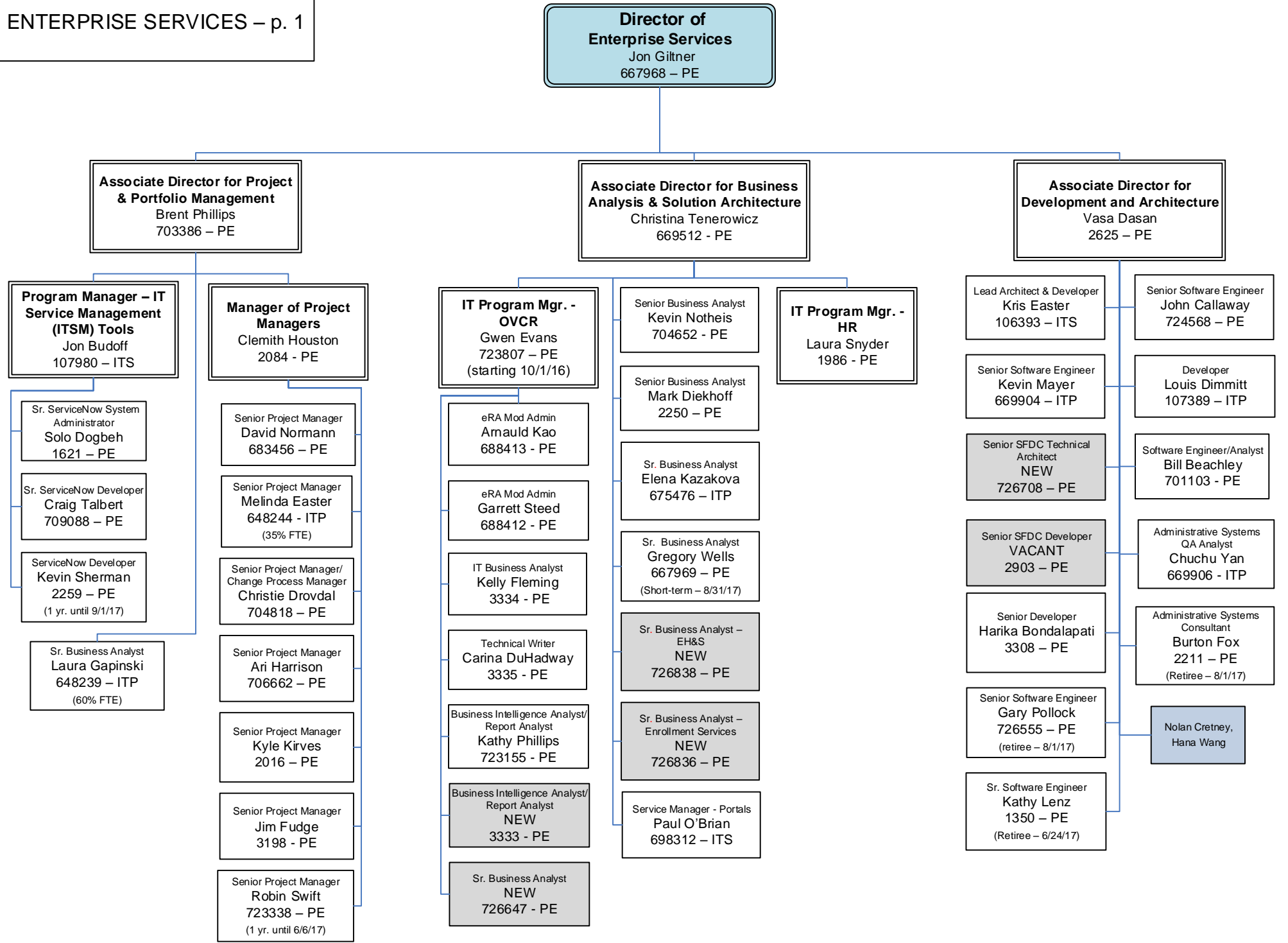

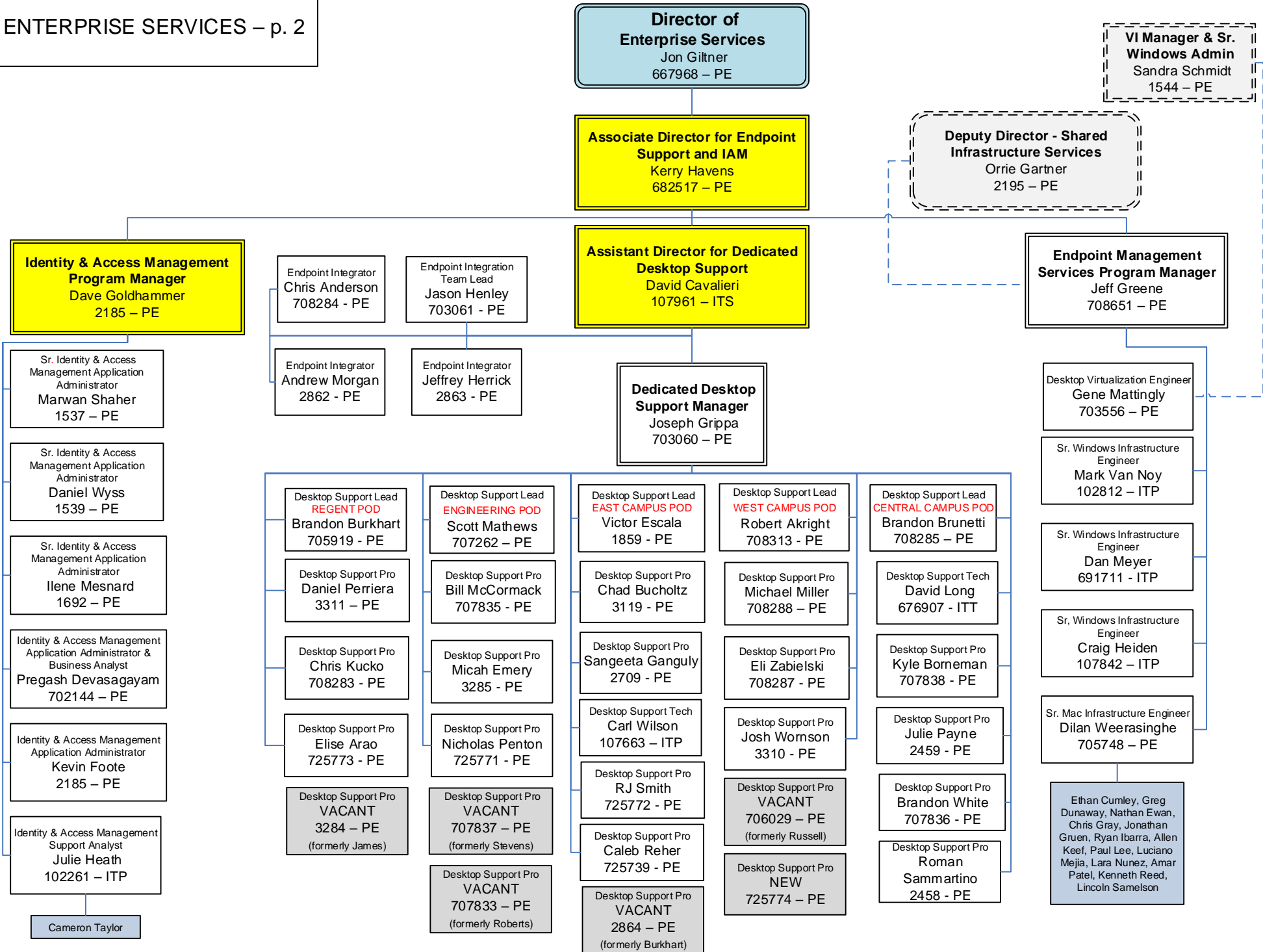

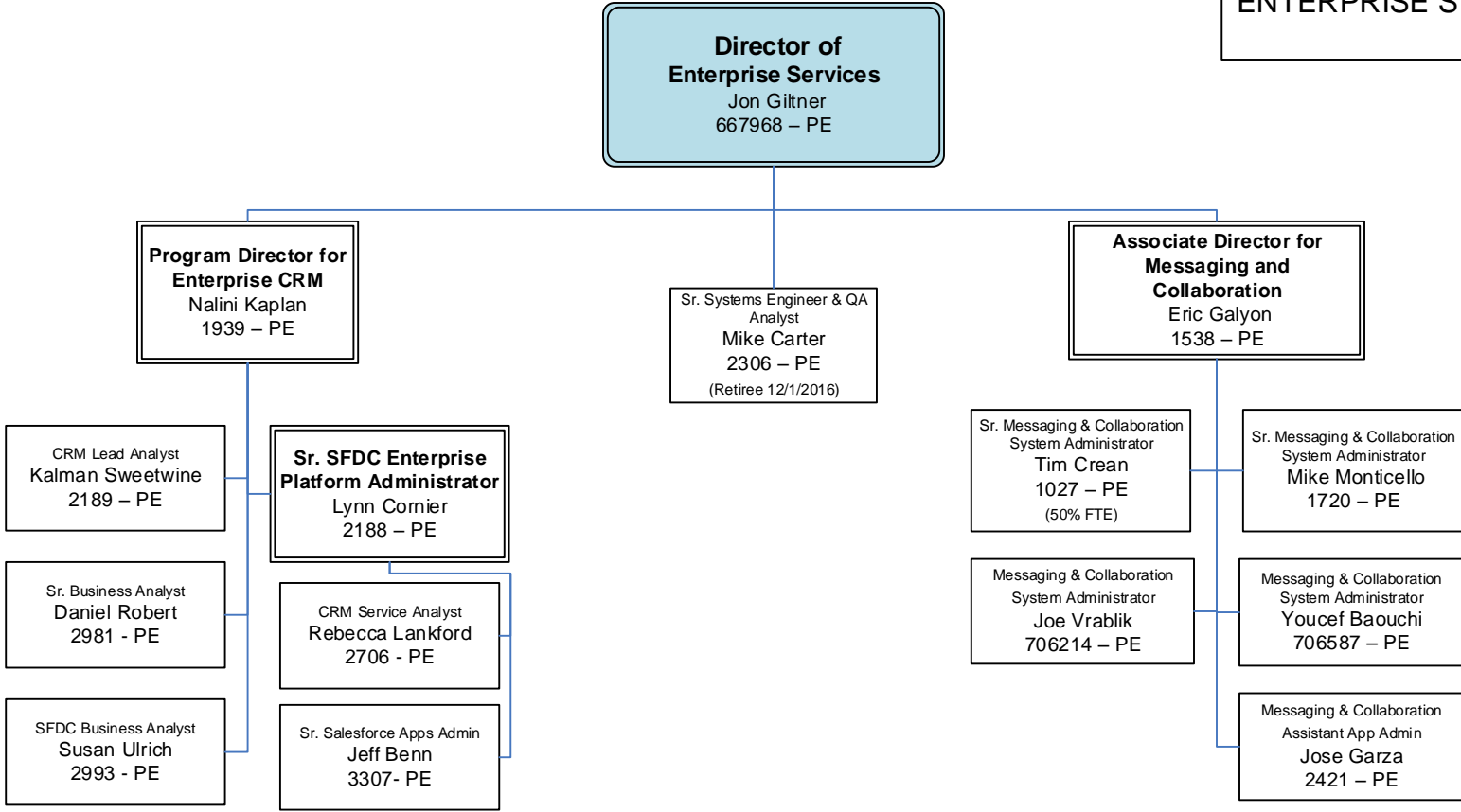

Director of IT Operations
 David Hamrick
 696185 – PE

Sr. OIT Operations
 Consultant
 David Bodnar
 702938 – PE
 (Retiree 12/31/16)

Program Manager
 Shared Infrastructure Services
 Lonnie Francescatti
 108006 - ITS

**Deputy Director – IT Operations
 Shared Infrastructure Services**
 Orrie Gartner
 2195 – PE

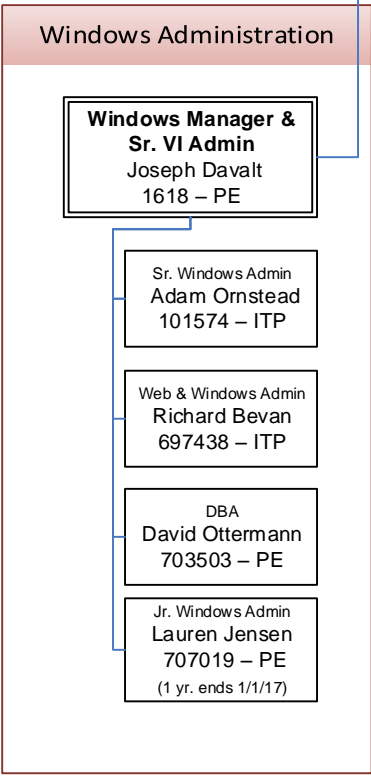
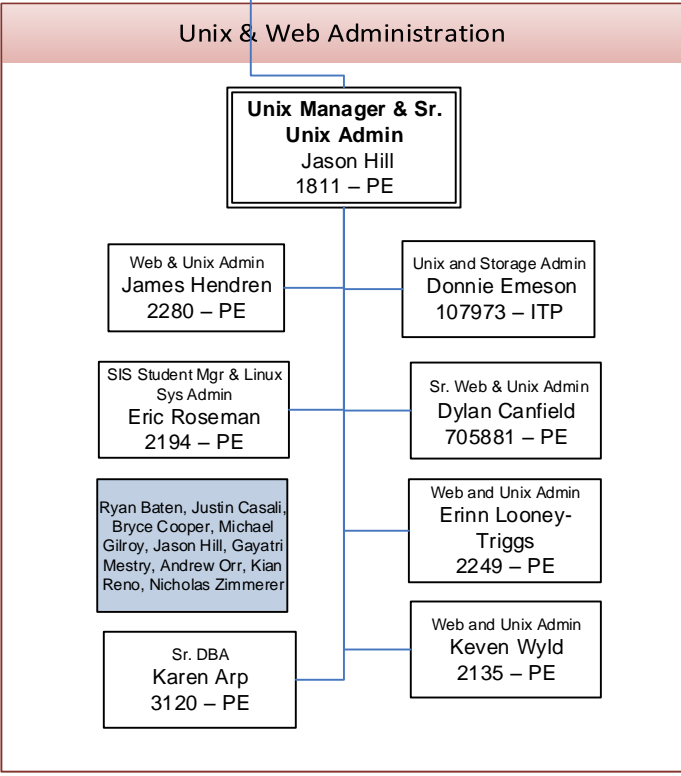
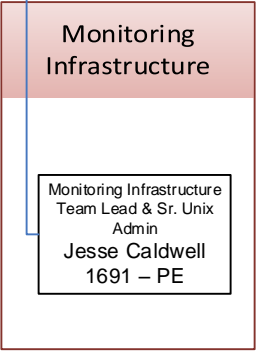
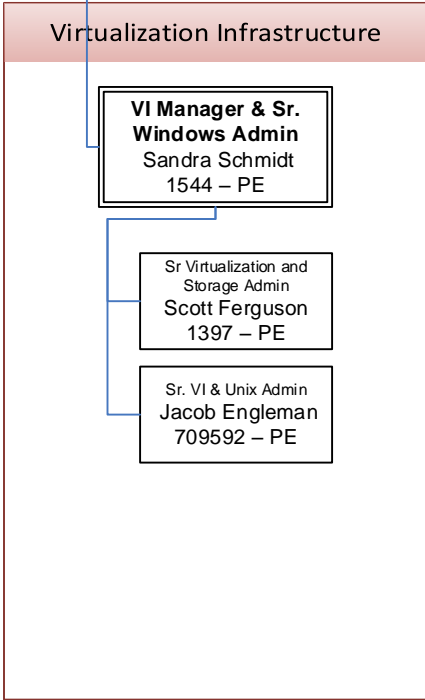

Director of Research
Computing
Thomas Hauser
694385 – PE

Director of IT Operations
David Hamrick
696185 – PE

**Program Manager
Construction &
Renovation**
Chris Evans
702141 - PE

**Associate Director for
Networks & Data Centers
Engineering & Operations**
Raymond Baum
2375 - PE

**Associate Director for
Voice Services & Physical
Infrastructure**
Jane Kenney
639345 – ITS

